

M2110P SMART PRESSURE GAUGE USER'S MANUAL



Meriam's M2110P Smart Pressure Gauge is a microprocessor-based pressure sensing device. The various ranges available provide measurement of differential (dry/dry or wet/wet), gauge, compound or absolute pressure. Three configurations are available: Battery, SetPoint, and Current Loop models.

All models are programmable through the front keypad. The user's program information is stored in non-volatile memory and is retained when the power to the gauge is removed. SetPoint and Current Loop models can also be configured through the RS-232 serial communication connection.

The Battery models are powered by internal lithium batteries. This model has an LCD for indication only; it does not support any outputs or RS-232 communications.

SetPoint and Current Loop models have outputs that can be used for control or indicating/recording functions. Both models also have RS-232 communications capability. In addition to configuring the gauge, the RS-232 port can be used to monitor and log the measured pressure data and output status. It can also be used as part of a control system with digital capabilities.

The SetPoint model provides two SPDT relay outputs with adjustable deadband. This configuration provides normally open or normally closed contact operation. Switch SetPoints can be set from -20% to +120% of the full scale pressure range. The SetPoint model is powered by 120/240 VAC, or 24VDC.

The Current Loop model provides a 4 to 20 mA output three or four wire pressure transmitter operation. LRV and URV are set through user-programmable registers from -20% to +120% of the full scale pressure range. The output is capable of normal and reverse action. The Current Loop model is powered by 24VDC only.

Safety Information











Failure to follow all instructions could result in injury. Read, understand and follow all safety warnings and instructions provided with this product. Also, meet or exceed your employer's safety practices.

In no event shall Meriam be liable for any indirect, special, incidental, consequential or punitive damages or for any lost profits arising out of or relating to any services provided by Meriam or its affiliates. It is not possible for Meriam to identify all foreseeable uses/misuses, therefore all persons involved in commissioning, using or maintaining this product must satisfy themselves that each intended application is acceptable.

Safety Warnings

The table below defines the safety symbols, signal words and corresponding safety messages used in the manual to identify potential hazards and are intended to warn persons about hazards that could result in personal injury or equipment damage.

| | |
|---|--|
|  | This is the Read Instruction Manual symbol. This symbol indicates that you must read the instruction manual. |
|  | This is the Safety Alert symbol. This symbol indicates a WARNING. Warnings alert you to actions that can cause personal injury or pose a physical threat. Please read these carefully. |
|  | This is the Safety Glasses symbol. This symbol indicates that you must wear approved safety glasses during the task. |
|  | This is the Safety Gloves symbol. This symbol indicates that you must wear approved safety gloves during the task. |
|  | Indicates a potentially hazardous situation which, if not avoided, will result in death or serious injury. |
|  | Indicates a potentially hazardous situation which, if not avoided, could result in death or serious injury. |
|  | Indicates a potentially hazardous situation which, if not avoided, could result in minor or moderate injury. |
|  | Indicates information essential for proper product installation, operation or maintenance. |

Information in this document is subject to change without notice. Check the Meriam web site (www.meriam.com) for the latest manual revision.

For customer assistance please call your local Meriam representative or Meriam directly.

Meriam Process Technologies
10920 Madison Avenue
Cleveland, Ohio 44102

Telephone: (216) 281-1100
Fax: (216) 281-0228

E-mail: meriam@meriam.com
Web: www.meriam.com

Table of Contents

| | |
|---|----|
| 1. Certification / Safety / Warnings..... | 4 |
| 2. Pressure Display..... | 5 |
| 3. Keypad Functions | 6 |
| 4. Programmable Register Overview | 8 |
| 5. Engineering Units | 9 |
| 6. Zero Reference..... | 10 |
| 7. P0 – Lockout Code All Models..... | 11 |
| 8. P1 – Time Out Value Battery Models Only | 12 |
| 9. P2 – Damp Rate All Models..... | 13 |
| 10. P3 – Density of Water Reference Temperature All Models..... | 14 |
| 11. P4 – User Scale All Models | 15 |
| 12. P5 – SETPOINT Options Set Point & Current Loop Models Only..... | 17 |
| 13. P6 & P7 – SETPOINT (Set1 & Set2) | 19 |
| 14. P8 – DEADBAND Set Point Models Only | 21 |
| 15. Lockout Code Prompt..... | 22 |
| 16. Serial Port Service | 23 |
| 17. Error Codes | 26 |
| 18. Installation & Wiring..... | 27 |
| 19. Outline Dimensions..... | 29 |
| 20. Panel Mounting..... | 29 |
| 21. Product Specifications | 30 |
| 22. Range Limits and Indication | 31 |
| 23. Service and Calibration..... | 32 |

1. Certification / Safety / Warnings

⚠ DANGER Fire/Explosion Hazard. This instrument is not intrinsically safe. DO NOT use or service in areas that may contain flammable gas or vapors, combustible dusts or ignitable fibers where an unintended spark can cause a fire/explosion.

⚠ WARNING Do not exceed the Pressure Limits listed in the Product Specifications section of this manual. Failure to operate within the specified pressure limit could result in death or serious injury.

⚠ CAUTION

- Do not exceed the Maximum Input Voltage listed under “Input Power Requirements” in the Specification section of this manual
- Do not exceed the Switch Rating listed under “I/O” in the Specifications section of this manual.
- Disconnect power before servicing.
- Substitution of components may impair operation and safety.

2. Pressure Display

Indicators

During normal operation, the gauge displays the pressure value in large numerals, and the bottom of the display shows the current Engineering Unit. The top of the display will show **PRGM** when the gauge is in **Program Mode** (flashing when “view only”). For SetPoint models, the top of the display will show **SET1/SET2** to indicate activated outputs (or corresponding register opened in **Program Mode**). For Current Loop models, the top of the display will show **4-20mA** when the output is enabled (or corresponding register opened in **Program Mode**). Finally, an **ABS** indicator illuminates when an Absolute Isolated sensor is used.

Performance

The M2110P Smart Gauge retrieves analog data from its pressure sensor, and performs an analog-to-digital (A/D) conversion for microprocessor-based data handling. The rate of A/D conversion will typically be between 10 to 14 conversions per second, depending on the various operating conditions.

To make the display easier to read, only every fourth sample is updated on the display. (This results in a display update rate of about 3 updates per second.) The internal calculations, outputs, and serial interface are updated at the full conversion rate.

Resolution

The display is limited to 4½ digits, and the resolution of the data (decimal point positioning) is defined by the range and sampling process. If a specific value will not fit on the 4½ digit display, however, the auto-range feature will decrease the resolution to allow the value to fit the display (for example, increasing past 199.99 becomes 200.0). The auto-range feature restores the decimal resolution with a built-in deadband of 5 display counts (for example, 200.0 must drop to 199.95 before the two-digit decimal resolution is restored).

Note that the full scale display indication during power-up will not necessarily have the same decimal resolution found during actual pressure monitoring.

3. Keypad Functions

The keys on the front panel perform multiple functions. Their function differs depending on whether the gauge is in **Measure Mode** or **Program Mode**.

- **Measure Mode** is the normal operating mode for measuring and displaying pressure. This mode is always default after power-up or reset.
- **Program Mode** is used to configure the various options of the gauge. This mode is denoted by a PRGM indicator on the display.

| | |
|---------------------------------------|---|
| ON/OFF / Backspace Key |  Document Symbol: (Backspace←) |
| Measure Mode | <ul style="list-style-type: none"> • Battery models: Toggles the gauge ON and OFF. • SetPoint and Current Loop models: “Resets” the gauge. <p><u>Sequence of power-up or reset</u></p> <ol style="list-style-type: none"> 1. Display test is performed (all segments of the LCD display are turned on). 2. Firmware revision is displayed. 3. Full scale range of sensor is displayed in the last Engineering Unit used. 4. All prior register values are restored and activated. 5. Measure Mode displays pressure in the last Engineering Unit used. |
| Program Mode | <p>Backspace function:</p> <p>From Program Mode, this key will exit to Measure Mode.</p> <p>When editing a register, this key is used to abort a programming operation and exit the register without making any changes.</p> <p>When editing a multi-digit value, each key press will backup one digit, until finally exiting the register.</p> |

| | |
|---------------------------------------|---|
| ENG UNITS/Up Arrow Key |  Document Symbol: (Up↑) |
| Measure Mode | <p>Allows the Engineering Units to be changed. During Engineering Unit selection, the current unit indicator remains solid, and the “new” unit indicator is flashed. Scrolling through the available units is done by pressing the Up↑ or Down↓ keys. The flashing unit is selected using the PRGM/Enter→ key, or the process may be aborted by using the Backspace← key.</p> |
| Program Mode (and EU Selection) | <p>Scroll up function. Scrolls up through the available programmable registers. Once a register is opened, this key allows editing by scrolling up through the values in the register.</p> |

| | |
|------------------------------------|---|
| Backlight/Down Arrow Key |  Document Symbol: (Down ↓) |
| Measure Mode | Toggles the display Backlight on and off. Note that the default Backlight status for the Battery model is OFF to conserve battery life. The other models will retain the prior Backlight status as default. |
| Program Mode (and EU Selection) | Scroll down function. Scrolls down through the available programmable registers. Once a register is opened, this key allows editing by scrolling down through the values in the register. |

| | |
|------------------------------------|---|
| PRGM/Enter Key |  Document Symbol: (PRGM/Enter →) |
| Measure Mode (and EU Selection) | Selects Program Mode , which allows access to the programmable registers. This key is also used to accept a new Engineering Unit selection. |
| Program Mode | Opens the selected programmable register for editing. When the desired value is displayed, pressing the PRGM/Enter → key accepts and stores the value, and closes the register. When editing a multi-digit value, each key press will accept the current digit and proceed to the next, until finally accepting the complete value and closing the register. |

| | |
|------------------------------------|---|
| Re-ZERO Key |  Document Symbol: (Up ↑ <i>and</i> Down ↓) |
| Measure Mode | In Measure Mode , pressing the Up ↑ <i>and</i> Down ↓ keys at the same time resets the zero reference of the gauge (see page Error! Bookmark not defined.). |
| Program Mode (and EU Selection) | In Program Mode , for convenience, this function will reset the current value to default. For example, in Program Mode (but before <i>opening</i> a register), this function will reset the register scroll to P0. After opening a register for editing, this function will reset the register's data value to default (typically 0). Similarly, when selecting a new Engineering Unit, this function will reset the selection to the first unit (InH ₂ O). Note that even when using this "reset" function, the PRGM/Enter → key must be pressed to accept the new value (this allows for further editing after reset of the value). |

4. Programmable Register Overview

All M2110P Smart Pressure Gauges have programmable registers that allow the gauge to be configured to fit the pressure measurement application. Programmable registers are numbered P0 through P8. Each register controls a specific aspect of the gauge's performance.

A description of all programmable registers, and step by step instructions for their use, is included below. Each register is found on all M2110 series models, and performs the same function described for all models, except as noted otherwise.

| Px | Name | Description | Value Range | Notes |
|----|--|--|--|-----------------------------|
| P0 | Lockout Code | Lockout for security. | 00 to 99 | 00 = Disabled. |
| P1 | Timeout | Automatic shutoff in minutes of keypad inactivity. | 0 (disabled), 1, 2, 5, 10, 15, 25 | Battery model only. |
| P2 | Damp Rate | Exponential damping time in seconds. | 0.1, 0.2, 0.5, 1, 2, 5, 10, 15, 25, 50 | 0.1 = No Damping. |
| P3 | Density of Water Reference Temperature | Sets reference temperature for water density when gauge is set for water column units. | 20°C, 4°C, or 60°F | |
| P4 | User Units Full Scale | Enables gauge to display units other than factory defined Engineering Units. | 0 to 9,999 (Keypad) 0 to 19,999 (Serial) | User defined value. |
| P5 | SetPoint Options | SetPoint Model: defines which relay outputs are active. | 0 = Disabled. 1 = SET1 only. 2 = SET2 only. 3 = Both enabled. | Not found on Battery model. |
| | | Current Loop Model: defines the status of the 4 - 20 mA output. | 0 = 4-20 disabled 1 = 4-20 enabled | |
| P6 | SET1 | Controls SET1 relay or 4.00 mA value. | -20% to +120% FS | User defined value. |
| P7 | SET2 | Controls SET2 relay or 20.0 mA value. | -20% to +120% FS | User defined value. |
| P8 | Deadband | Sets the amount of deadband in percent of full scale for relays. | 0 (disabled), 0.1, 0.2, 0.5, 1, 2, 5, 10% | SetPoint model only. |

5. Engineering Units

The following Engineering Units are available on the M2110P:

1. **InH₂O** – Inches of Water Column (ref. temp. selections: 20°C, 4°C, 60°F)
2. **PSI** – Pounds per Square Inch
3. **Kg/cm²** – Kilograms per Centimeter squared
4. **kPa** – KiloPascals
5. **mBar** – milliBar
6. **Bar** – Bar
7. **cmH₂O** – Centimeters of Water Column (ref. temp. selections: 20°C, 4°C, 60°F)
8. **inHg** – Inches of Mercury Column (ref. temp. 0°C)
9. **mmHg** – milliMeters of Mercury Column (ref. temp. 0°C)
10. **User Units** – User Defined Units

| STEP BY STEP: CHANGING ENGINEERING UNITS | | |
|---|--|---|
| Step | Action | Display |
| 1 | Gauge should be in the normal Measure Mode . | Normal Pressure Display. |
| 2 | Press the ENG UNITS (Up↑) key. If the lockout is active, the gauge will now prompt for entry of the lockout code. Refer to “STEP BY STEP: ENTERING A LOCKOUT CODE (When Prompted)” on page 22. | Current Engineering Unit ¹ indicator flashes. |
| 3 | Press the Up↑ or Down↓ keys repeatedly to scroll to the desired Engineering Unit. The Zero function (Up↑ and Down↓) will reset the scroll to the first unit and allow selection to continue. | The current Engineering Unit indicator remains solid since it is active, and the unit to be selected flashes as the list is scrolled. |
| 4 | Press the PRGM/Enter→ key when the desired unit is flashing. | The display switches to the new Engineering Unit ² and returns to Measure Mode . |
| Notes | <ol style="list-style-type: none"> 1. When scrolling through Engineering Units, <i>User Units</i> are denoted by all units flashing. 2. In Measure Mode, <i>User Units</i> are denoted by no Engineering Unit indicators shown on the bottom of the display. 3. Changing the Engineering Unit will automatically update the setpoint registers as appropriate (refer to the Automatic Update section on page 19 for further explanation). 4. At any time, the Backspace← key will abort the process and return to Measure Mode. 5. If there is no keypad activity for approximately 1 minute, the operation is aborted and the gauge returns to Measure Mode unchanged. | |

6. Zero Reference

Zeroing the gauge consists of accepting the current pressure value as the zero pressure reference. To set the zero reference pressure, all pressure sources should be disconnected from the gauge, and its temperature should be stable.

The pressure reading of the gauge is linearly offset from the zero reference value. Absolute-Isolated pressure sensors are theoretically zero-referenced to absolute zero pressure (perfect vacuum), and cannot be re-zeroed without a vacuum source.

AFFECT ON OUTPUTS

The SetPoint and Current Loop outputs are calculated based on the displayed pressure. Since re-zeroing the gauge may change the displayed pressure, the outputs may change accordingly. For safety purposes, an extra step is required to warn the operator and confirm the desired action. For clarity, both scenarios are described below, step-by-step.

FACTORY ZERO

The “Factory Zero” can be restored through the serial port service only (SetPoint and Current Loop models only). This is the value set during calibration of the sensor, and is typically 0.0.

RANGE CHECK

The M2110P can be zeroed only when the applied pressure is within $\pm 5\%$ of full scale. If the applied pressure is greater than 5% of full scale, an error code will be displayed when zeroing is attempted.

| STEP BY STEP: RE-ZEROING THE GAUGE (Disabled Outputs, P5=0) | | |
|--|--|--|
| Step | Action | Display |
| 1 | Gauge should be in normal Measure Mode , and the applied pressure is ready for zeroing (typically vented, or vacuumed for absolute sensors). | Normal pressure display, near 0.0. |
| 2 | Press the Up↑ and Down↓ keys simultaneously. If the lockout is active, the gauge will now prompt for entry of the lockout code. Refer to “STEP BY STEP: ENTERING A LOCKOUT CODE (When Prompted)” on page 22. | The display will flash “0000” several times while the new zero is taken, and then return to Measure Mode with the new zero activated. |

| WHEN OUTPUTS ARE ACTIVE (P5>0) ... SetPoint and Current Loop models only | | |
|--|--|---|
| 1 | Gauge should be in normal Measure Mode , and the applied pressure is ready for zeroing (typically vented, or vacuumed for absolute sensors). | Normal pressure display, near 0.0. |
| 2 | Press the Up↑ and Down↓ keys simultaneously. If the lockout is active, the gauge will now prompt for entry of the lockout code. Refer to “STEP BY STEP: ENTERING A LOCKOUT CODE (When Prompted)” on page 22. | The display will begin countdown from “0005” to “0000”. |

| | | |
|--------------|--|--|
| 3 | Press PRGM/Enter → before the countdown expires ¹ . This acknowledges the warning. | The display will again countdown from “0005” to “0000”. |
| 4 | Press ZERO again (Up ↑ and Down ↓) before the countdown expires ¹ . This confirms the zero action. | The display will flash “0000” several times while the new zero is taken. |
| Notes | 1. During steps 2 or 3, if the countdown expires, the gauge will return to Measure Mode unchanged. 2. During steps 2 or 3, the Backspace ← key will abort the process and return to Measure Mode . | |

7. P0 – Lockout Code All Models

This feature provides security in the M2110P. It is designed to prevent unauthorized personnel from tampering with or inadvertently changing the configuration of the gauge. The lockout is controlled by a 2-digit setting in the P0 register. Once a lockout code is entered, the gauge will prompt for the lockout code before allowing any changes (similar to a “password”). Changes include Engineering Unit selection, re-zeroing, or entering **Program Mode**.

Following an operator action, if the correct code (password) is not entered when prompted, an error message is briefly displayed. If the operator action was changing Engineering Units or re-zero the gauge, the gauge will simply return to normal **Measure Mode** operation, without accepting any change. If the operator action was entering **Program Mode**, the gauge will enter a “view-only” status (see page 22), denoted by the PRGM indicator flashing.

In **Program Mode** (and during lockout code prompting), the register value is shown as “L xx” to assist in identifying the register. The “L ” indicates “Lockout”, and “xx” will consist of the current value.

| QUICK REFERENCE: P0, LOCKOUT CODE | | | | |
|--|--------------|-----------------------|-------------|----------------|
| Px | Name | Description | Value Range | Notes |
| P0 | Lockout Code | Lockout for security. | 00 to 99 | 00 = Disabled. |

| STEP BY STEP: P0, LOCKOUT CODE | | |
|---------------------------------------|---|---|
| Step | Action | Display |
| 1 | Gauge should be in the normal Measure Mode . | Normal Pressure Display. |
| 2 | Press the PRGM/Enter → key. If the lockout is active, the gauge will now prompt for entry of the lockout code. Refer to “STEP BY STEP: ENTERING A LOCKOUT CODE (When Prompted)” on page 22. | The PRGM annunciator shows at the top of the display, and the display shows the register name “ P0 ”. |
| 3 | Press PRGM/Enter → again, to open the register. | The display will show “ L xy ” with the first digit flashing for edit (indicating <u>L</u> ockout Code xy). |
| 4 | Press the Up ↑ or Down ↓ keys repeatedly to scroll to the desired numeric value for the flashing digit. | “ L _x ”, where “_” is the digit being edited (flashing). |

| | | |
|--------------|---|---|
| | The Zero function (Up↑ and Down↓) will reset the entire register to 00 and allow editing to continue. | |
| 5 | Press the PRGM/Enter→ key to accept the digit. | The next digit begins flashing for edit. |
| 6 | Repeat steps 4 and 5 for the second digit. | The complete 2-digit value will be accepted, and the register is closed (display shows P0 for selection). |
| 7 | Press the Backspace← key to activate the lockout and return to Measure Mode . | Normal Pressure Display. |
| Notes | <ol style="list-style-type: none"> After step 2, the Backspace← key will abort the process and return to Measure Mode. After steps 3 or 4, the Backspace← key will abort the current digit and close the register (since it is the first digit). After step 5, the Backspace← key will abort the current digit and backup to the first digit. Another Backspace← will abort the process and close the register. After step 6, the PRGM/Enter→ key will again open the register for edit. During any programming operation, if there is no keypad activity for approximately 1 minute, the operation is aborted and the gauge returns to Measure Mode unchanged. | |

8. P1 – Time Out Value Battery Models Only

This register sets the length of time (in minutes) for automatic shutoff. The Battery model will automatically shutoff if there is no keypad activity for this length of time. This feature can be disabled by selecting 0 in the register, which allows the gauge to remain on indefinitely, or until the ON/OFF key is pressed (battery life may be reduced). During programming, the choices found in the register correspond to the actual timeout values, in minutes.

| QUICK REFERENCE: P1, TIMEOUT | | | | |
|-------------------------------------|---------|--|--------------------------------------|---------------------|
| Px | Name | Description | Value Range | Notes |
| P1 | Timeout | Automatic shutoff in minutes of keypad inactivity. | 0 (disabled), 1, 2, 5, 10, 15, 25 | Battery model only. |

| STEP BY STEP: P1, TIMEOUT | | |
|----------------------------------|--|---|
| Step | Action | Display |
| 1 | Gauge should be in the normal Measure Mode . | Normal Pressure Display. |
| 2 | Press the PRGM/Enter→ key. If the lockout is active, the gauge will now prompt for entry of the lockout code. Refer to “STEP BY STEP: ENTERING A LOCKOUT CODE (When Prompted)” on page 22. | The PRGM annunciator shows at the top of the display, and the display shows the register name “ P0 ”. |

| | | |
|--------------|--|--|
| 3 | Press the Up↑ or Down↓ keys repeatedly to scroll to the desired register. | Display shows “P1”. |
| | The Zero function (Up↑ and Down↓) will reset the scroll to P0 and allow selection to continue. | |
| 4 | Press PRGM/Enter→ to open the register. | The display shows the current value. |
| 5 | Press the Up↑ or Down↓ keys repeatedly to scroll to the desired register value. | All available choices are scrolled. (Choices indicate actual Timeout in seconds.) |
| | The Zero function (Up↑ and Down↓) will reset the scroll to default and allow editing to continue. | |
| 6 | Press the PRGM/Enter→ key to accept the desired value. | The value is accepted, and the register is closed. Display shows “P1”. |
| 7 | Press the Backspace← key to activate the register setting and return to Measure Mode . | Normal Pressure Display. |
| Notes | <ol style="list-style-type: none"> After steps 2 and 3, the Backspace← key will abort the process and return to Measure Mode. After steps 4 and 5, the Backspace← key will abort the edit and close the register. After step 6, the PRGM/Enter→ key will again open the register for edit. During any programming operation, if there is no keypad activity for approximately 1 minute, the operation is aborted and the gauge returns to Measure Mode unchanged. | |

9. P2 – Damp Rate All Models

The M2110P has a selectable damp rate, which is used to stabilize the display for applications with a pulsating pressure source. The damp rate setting is roughly the length of time it will take for the gauge to ramp from one stable pressure to another. The ramping is exponential, changing at a slower rate as the final value is approached.

The “time constant” of the exponential equation is roughly one-fifth of the damp rate setting. This means that the damped value will be roughly 63% of final value after a time equal to one-fifth of the register setting. The value will be roughly 86% of final value after a time equal to two-fifths of the register setting.

The damping function only affects the displayed value (LCD display and RS232 data); it does not affect the action of the SPDT relays, the 4 to 20 mA outputs, or the response to over-pressure (“OP” indication).

| QUICK REFERENCE: P2, DAMP RATE | | | | |
|---------------------------------------|-----------|--------------------------------------|--|-------------------|
| Px | Name | Description | Value Range | Notes |
| P2 | Damp Rate | Exponential damping time in seconds. | 0.1, 0.2, 0.5, 1, 2, 5, 10, 15, 25, 50 | 0.1 = No Damping. |

| STEP BY STEP: P2, DAMP RATE | | |
|------------------------------------|--|---|
| Step | Action | Display |
| 1 | Gauge should be in the normal Measure Mode . | Normal Pressure Display. |
| 2 | Press the PRGM/Enter→ key. | The PRGM annunciator shows at the top of the display, and the display shows the register name " P0 ". |
| | If the lockout is active, the gauge will now prompt for entry of the lockout code. Refer to "STEP BY STEP: ENTERING A LOCKOUT CODE (When Prompted)" on page 22. | |
| 3 | Press the Up↑ or Down↓ keys repeatedly to scroll to the desired register. | Display shows " P2 ". |
| | The Zero function (Up↑ and Down↓) will reset the scroll to P0 and allow selection to continue. | |
| 4 | Press PRGM/Enter→ to open the register. | The display shows the current value. |
| 5 | Press the Up↑ or Down↓ keys repeatedly to scroll to the desired register value. | All available choices are scrolled. (Choices indicate actual damp rate in seconds.) |
| | The Zero function (Up↑ and Down↓) will reset the scroll to default and allow editing to continue. | |
| 6 | Press the PRGM/Enter→ key to accept the desired value. | The value is accepted, and the register is closed. Display shows " P2 ". |
| 7 | Press the Backspace← key to activate the register setting and return to Measure Mode . | Normal Pressure Display. |
| Notes | <ol style="list-style-type: none"> After steps 2 and 3, the Backspace← key will abort the process and return to Measure Mode. After steps 4 and 5, the Backspace← key will abort the edit and close the register. After step 6, the PRGM/Enter→ key will again open the register for edit. During any programming operation, if there is no keypad activity for approximately 1 minute, the operation is aborted and the gauge returns to Measure Mode unchanged. | |

10. P3 – Density of Water Reference Temperature All Models

The M2110P supports pressure units of inches of water column and centimeters of water column, at three different water temperature references: **20°C**, **4°F** and **60°F**. The base reference temperature is 20°C on all gauges. This register is used to change to one of the other standards. During programming, the corresponding choices found in the register are "20", "4", and "60" respectively (the temperature unit cannot be shown due to display limitations).

| QUICK REFERENCE: P3, DENSITY OF WATER REFERENCE TEMP | | | | |
|---|--|--|---------------------|--------------|
| Px | Name | Description | Value Range | Notes |
| P3 | Density of Water Reference Temperature | Sets reference temperature for water density when gauge is set for water column units. | 20°C 4°C 60°F | |

| STEP BY STEP: P3, DENSITY OF WATER REFERENCE TEMP | | |
|--|--|---|
| Step | Action | Display |
| 1 | Gauge should be in the normal Measure Mode . | Normal Pressure Display. |
| 2 | Press the PRGM/Enter→ key. If the lockout is active, the gauge will now prompt for entry of the lockout code. Refer to "STEP BY STEP: ENTERING A LOCKOUT CODE (When Prompted)" on page 22. | The PRGM annunciator shows at the top of the display, and the display shows the register name " P0 ". |
| 3 | Press the Up↑ or Down↓ keys repeatedly to scroll to the desired register. The Zero function (Up↑ and Down↓) will reset the scroll to P0 and allow selection to continue. | Display shows " P3 ". |
| 4 | Press PRGM/Enter→ to open the register. | The display shows the current value. |
| 5 | Press the Up↑ or Down↓ keys repeatedly to scroll to the desired register value. The Zero function (Up↑ and Down↓) will reset the scroll to default and allow editing to continue. | All available choices are scrolled. "20" = 20 Deg. C "4" = 4 Deg. C "60" = 60 Deg. F |
| 6 | Press the PRGM/Enter→ key to accept the desired value. | The value is accepted, and the register is closed. Display shows " P3 ". |
| 7 | Press the Backspace← key to activate the register setting and return to Measure Mode . | Normal Pressure Display. |
| Notes | <ol style="list-style-type: none"> After steps 2 and 3, the Backspace← key will abort the process and return to Measure Mode. After steps 4 and 5, the Backspace← key will abort the edit and close the register. After step 6, the PRGM/Enter→ key will again open the register for edit. During any programming operation, if there is no keypad activity for approximately 1 minute, the operation is aborted and the gauge returns to Measure Mode unchanged. | |

11. P4 – User Scale All Models

The user scale feature is provided in addition to the standard Engineering Unit choices, to allow the display of measured pressure in any Engineering Unit. The full scale value of the sensor is linearly re-scaled to the value entered in this register. This is particularly useful for displaying linear tank levels in volumetric or mass units.

For example, a 20 PSIG gauge is programmed to read out in feet of water head by entering 46.22 in the P4 register. This sets the gauge to read from 0 to 46.22 feet of water, when User Units are selected as the Engineering Units (46.22 feet of water at 20°C is equal to 20 PSIG).

User Engineering Units are selected when ALL Engineering Units are flashing during the Engineering Unit selection process. Once selected, in **Measure Mode**, all Engineering Units are cleared from the display to denote user-units.

QUICK REFERENCE: P4, USER SCALE

| Px | Name | Description | Value Range | Notes |
|----|-----------------------|--|---|---------------------|
| P4 | User Units Full Scale | Enables gauge to display units other than factory defined Engineering Units. | 0 to 9,999 (Keypad) 0 to 19,999 (Serial) | User defined value. |

STEP BY STEP: P4, USER SCALE

| Step | Action | Display |
|------|---|--|
| 1 | Gauge should be in the normal Measure Mode . | Normal Pressure Display. |
| 2 | Press the PRGM/Enter→ key. If the lockout is active, the gauge will now prompt for entry of the lockout code. Refer to "STEP BY STEP: ENTERING A LOCKOUT CODE (When Prompted)" on page 22. | The PRGM annunciator shows at the top of the display, and the display shows the register name " P0 ". |
| 3 | Press the Up↑ or Down↓ keys repeatedly to scroll to the desired register. The Zero function (Up↑ and Down↓) will reset the scroll to P0 and allow selection to continue. | Display shows " P4 ". |
| 4 | Press PRGM/Enter→ to open the register. | The display will show the current value, with the first digit flashing for edit. |
| 5 | Press the Up↑ or Down↓ keys repeatedly to scroll to the desired numeric value for the flashing digit. The Zero function (Up↑ and Down↓) will reset the entire register to 0000 and allow editing to continue. The decimal point will not be affected, and same digit will be flashing. | "_xxx", where "_" is the digit being edited (flashing). |
| 6 | Press the PRGM/Enter→ key to accept the digit. | The next digit begins flashing for edit. |
| 7 | Repeat steps 5 and 6 for the all remaining digits. The Backspace← key will backup one digit at a time, or abort and close the register if the first digit is flashing. The PRGM/Enter→ key will accept one digit at a time, moving to the next, or accept the complete value and close the register after the decimal point edit. | After Enter→ when the last digit is flashing, the decimal point flashes for edit. <i>Please read carefully note 4 below.</i> |
| 8 | Press the Up↑ or Down↓ keys repeatedly to scroll to the desired decimal point position. If the Zero function (Up↑ and Down↓) is used during decimal point editing, it will still reset the register's value to 0000, and not affect the decimal point position. | Decimal point moves accordingly. <i>Please read carefully note 4 below.</i> |
| 9 | Press the PRGM/Enter→ key to accept the complete value. | The value is accepted, and the register is closed. Display shows " P4 ". |
| 10 | Press the Backspace← key to activate the register setting and return to Measure Mode . | Normal Pressure Display. |

STEP BY STEP: P4, USER SCALE

| Step | Action | Display |
|--------------|--|---------|
| Notes | <ol style="list-style-type: none"> 1. Preceding/Trailing zeroes are determined by where the user places the decimal point. When opening a register, the value is always shown padded with trailing zeroes. 2. Only 4 digits are available for editing (the ½ digit is not provided), plus the decimal point and negative sign (negative is not applicable to register P4). This limits keypad value entries to ±9,999, and also limits the available decimal point resolution (depending on the magnitude of the value). The serial interface provides much more flexibility. 3. After steps 2 and 3, the Backspace← key will abort the process and return to Measure Mode. 4. The display does not have a physical decimal point that can be illuminated in the least significant position (to the right of all digits on the display). Thus, if the decimal point is in that particular position, there will be no decimal point blinking (which may be confusing). When scrolling through the decimal point selection, it is important to take note that none blinking is a viable setting, and will be seen in the scrolling sequence. 5. After step 9, the PRGM/Enter→ key will again open the register for edit. 6. During any programming operation, if there is no keypad activity for approximately 1 minute, the operation is aborted and the gauge returns to Measure Mode unchanged. | |

12. P5 – SETPOINT Options Set Point & Current Loop Models Only

This register defines the output action for SetPoint and Current Loop models. Note that if an output is disabled by this register, the setpoint value in its corresponding register (P6, P7) has no impact. Also note that a setpoint value (P6, P7) may be 0.0, which is a viable output setting; thus, in order to *disable* control action, register P5 should be used to define the desired action.

In **Measure Mode**, the indicators “SET1” and/or “SET2” will illuminate when the corresponding relay is energized. The “4-20mA” indicator will illuminate when the Current Loop output is enabled. In **Program Mode**, the indicators “SET1”, “SET2”, and “4-20mA” will illuminate as appropriate to assist when scrolling through the register’s choices. *Note that if P5 is set for active, the outputs will continue to update even in Program Mode, according to the currently programmed values.*

QUICK REFERENCE: P5, SETPOINT OPTIONS

| Px | Name | Description | Value Range | Notes |
|----|------------------|---|--|------------------------------------|
| P5 | SetPoint Options | <u>SetPoint model:</u> Defines which relay outputs are active. | 0 = Disabled. 1 = SET1 only. 2 = SET2 only. 3 = Both enabled. | Not found on <u>Battery model.</u> |
| | | <u>Current Loop model:</u> Defines status of the 4-20 mA output. | 0 = 4-20 disabled 1 = 4-20 enabled | |

STEP BY STEP: P5, SETPOINT OPTIONS

| Step | Action | Display |
|--------------|--|---|
| 1 | Gauge should be in the normal Measure Mode . | Normal Pressure Display. |
| 2 | Press the PRGM/Enter→ key. If the lockout is active, the gauge will now prompt for entry of the lockout code. Refer to "STEP BY STEP: ENTERING A LOCKOUT CODE (When Prompted)" on page 22. | The PRGM annunciator shows at the top of the display, and the display shows the register name " P0 ". |
| 3 | Press the Up↑ or Down↓ keys repeatedly to scroll to the desired register. The Zero function (Up↑ and Down↓) will reset the scroll to P0 and allow selection to continue. | Display shows " P5 ". |
| 4 | Press PRGM/Enter→ to open the register. | The display shows the current value. |
| 5 | Press the Up↑ or Down↓ keys repeatedly to scroll to the desired register value. The Zero function (Up↑ and Down↓) will reset the scroll to default and allow editing to continue. | All available choices are scrolled. |
| 6 | Press the PRGM/Enter→ key to accept the value. | The value is accepted, and the register is closed. Display shows " P5 ". |
| 7 | Press the Backspace← key to activate the register setting and return to Measure Mode . | Normal Pressure Display. |
| Notes | <ol style="list-style-type: none"> 1. After steps 2 and 3, the Backspace← key will abort the process and return to Measure Mode. 2. After steps 4 and 5, the Backspace← key will abort the edit and close the register. 3. After step 6, the PRGM/Enter→ key will again open the register for edit. 4. During any programming operation, if there is no keypad activity for approximately 1 minute, the operation is aborted and the gauge returns to Measure Mode unchanged. | |

13. P6 & P7 – SETPOINT (Set1 & Set2)

SetPoint Model

These registers define the pressure points at which the SPDT relays will energize. The relay will energize when the pressure exceeds its corresponding value, and de-energize when the pressure drops below the value (minus deadband; Register P8). P6 defines the SET1 relay, and P7 defines the SET2 relay. P6 and P7 settings are completely independent of each other; either may be greater, less than, or equal to the other.

Current Loop Model

These registers define the 4 to 20 mA output value. P6 (SET1) sets the 4.00 mA output and P7 (SET2) sets the 20.00 mA output. (Thus, the output “zero” is defined by SET1, and the “span” is defined by SET2 – SET1.) When the pressure is at the P6 value, the output will be 4.00 mA; when the pressure is at the P7 value, the output will be 20.00 mA. Other pressures provide an output that is linearly scaled between the two values. For values beyond the defined range, however, the output is limited from 4.00 to 20.38 mA. The P6 (4 mA) register can be set greater than the P7 (20 mA) register, to create a reverse acting output. The limits are –20% to +120% full scale, but P6 and P7 cannot be set equal.

Data Entry

Refer to the Step by Step table below for detailed instructions.

These registers are entered in the current Engineering Unit used by the gauge. (The current Engineering Unit is illuminated during edit of these registers.) For example, if the gauge is set to read in InH₂O (at 20°C), and a value of 110 is put into the P6 register, the SET1 relay will energize at 110 InH₂O (at 20°C).

In **Program Mode**, the indicators “**SET1**”, “**SET2**”, and “**4-20mA**” will illuminate as appropriate to assist in identifying the register. For example, when scrolling to and/or editing P6, “**SET1**” will be illuminated, indicating that SET1 is being edited. Likewise for P7 and “**SET2**”. Also, “**4-20mA**” will be illuminated if the gauge is a Current Loop model, to indicate that the 4-20mA range is being edited.

Automatic Update

If the Engineering Unit is changed, the value in the P6 and P7 registers will automatically change to reflect the new Engineering Unit. This allows changing the Engineering Unit in **Measure Mode** without affecting the outputs. For the above example, changing the Engineering Unit to inches of mercury will automatically update the P6 register to energize at 8.077 inches of mercury, which is equivalent to 110 InH₂O (at 20°C).

Also, if the water density reference temperature (P3) is changed, and the current Engineering Unit is water column based, these registers will update as appropriate. For the above example, changing the reference temperature to 4°C will automatically update the P6 register to energize at 109.81 InH₂O (at 4°C), which is equivalent to 110 InH₂O (at 20°C).

QUICK REFERENCE: P6/P7, SETPOINTS

| Px | Name | Description | Value Range | Notes |
|----|------|--|--------------------------------|---|
| P6 | SET1 | <u>SetPoint model:</u> Controls SET1 relay. | -20% to +120% of Full Scale | User defined values. On Current Loop models, SET1 cannot equal SET2. |
| | | <u>Current Loop model:</u> Sets 4.00 mA value. | | |
| P7 | SET2 | <u>SetPoint model:</u> Controls SET2 relay. | -20% to +120% of Full Scale | |
| | | <u>Current Loop model:</u> Sets 20.00 mA value. | | |

STEP BY STEP: P6/P7, SETPOINTS

| Step | Action | Display |
|------|---|--|
| 1 | Gauge should be in the normal Measure Mode . | Normal Pressure Display. |
| 2 | Press the PRGM/Enter→ key. | The PRGM annunciator shows at the top of the display, and the display shows the register name " P0 ". |
| | If the lockout is active, the gauge will now prompt for entry of the lockout code. Refer to "STEP BY STEP: ENTERING A LOCKOUT CODE (When Prompted)" on page 22. | |
| 3 | Press the Up↑ or Down↓ keys repeatedly to scroll to the desired register. | Display shows " P6 " or " P7 ". Also, " SET1 " or " SET2 " respectively is displayed to help identify the register, in addition to " 4-20mA " for Current Loop Models. |
| | The Zero function (Up↑ and Down↓) will reset the scroll to P0 and allow selection to continue. | |
| 4 | Press PRGM/Enter→ to open the register. | The display will show the current value, with the first zero flashing for edit. |
| 5 | Press the Up↑ or Down↓ keys repeatedly to scroll to the desired numeric value for the flashing digit. | " _xxx ", where " _ " is the digit being edited. |
| | The Zero function (Up↑ and Down↓) will reset the entire register to 0000 and allow editing to continue. The decimal point and negative sign will not be affected, and same digit will be flashing. | |
| 6 | Press the PRGM/Enter→ key to accept the digit. | The next digit begins flashing for edit. |
| 7 | Repeat steps 5 and 6 for all the remaining digits. | After Enter→ when the last digit is flashing, the decimal point flashes for edit. <i>Please read carefully note 4 on page 17.</i> |
| | The Backspace← key will backup one digit at a time, or abort and close the register if the first digit is flashing. The PRGM/Enter→ key will accept one digit at a time, moving to the next, or accept the complete value and close the register after the decimal point edit. | |

| | | |
|--------------|---|---|
| 8 | Press the Up↑ or Down↓ keys repeatedly to scroll to the desired decimal point position, and to select positive/negative. | Decimal point moves accordingly. <i>Please read carefully note 4 on page 17.</i> Negative Sign activates and de-activates when the decimal point sequence is scrolled through completely. |
| | If the Zero function (Up↑ and Down↓) is used during decimal point editing, it will still reset the register's value to 0000, and not affect the decimal point position or negative sign. | |
| 9 | Press the PRGM/Enter→ key to accept the complete value. | The value is accepted, and the register is closed. Display shows " P6 " or " P7 ". |
| 10 | Press the Backspace← key to activate the register setting and return to Measure Mode . | Normal Pressure Display. |
| Notes | Please refer to the "notes" section for P4 (User Scale) on page 17. The editing process is the same. | |

14. P8 – DEADBAND Set Point Models Only

This register is found on the SetPoint model only. It sets the adjustable deadband for the SPDT relays. Deadband can be set to 0%, 0.1, 0.2, 0.5, 1, 2, 5 and 10% of full scale. The relay will energize precisely at the value in its corresponding P6 and P7 registers on increasing pressure. The relay will de-energize at a value equal to the corresponding P6 and P7 register, minus the deadband value, on decreasing pressure. With a 0% deadband setting, the relays will energize and reset precisely at the values in the corresponding P6 and P7 registers. During programming, the choices found in the register correspond to the actual deadband values in percent full scale.

QUICK REFERENCE: P8, DEADBAND

| Px | Name | Description | Value Range | Notes |
|----|----------|--|-----------------------------------|---------------------------------------|
| P8 | Deadband | Sets the amount of deadband in percent of full scale for relays. | 0, 0.1, 0.2, 0.5, 1, 2, 5, 10% FS | SetPoint model only. 0 = Disabled. |

STEP BY STEP: P8, DEADBAND

| Step | Action | Display |
|------|---|---|
| 1 | Gauge should be in the normal Measure Mode . | Normal Pressure Display. |
| 2 | Press the PRGM/Enter→ key. | The PRGM annunciator shows at the top of the display, and the display shows the register name " P0 ". |
| | If the lockout is active, the gauge will now prompt for entry of the lockout code. Refer to "STEP BY STEP: ENTERING A LOCKOUT CODE (When Prompted)" on page 22. | |
| 3 | Press the Up↑ or Down↓ keys repeatedly to scroll to the desired register. | Display shows " P8 ". |
| | The Zero function (Up↑ and Down↓) will reset the scroll to P0 and allow selection to continue. | |
| 4 | Press PRGM/Enter→ to open the register. | The display shows the current value. |

| | | |
|--------------|--|---|
| 5 | Press the Up ↑ or Down ↓ keys repeatedly to scroll to the desired register value. | All available choices are scrolled. (Choices indicate actual Deadband in percent of full scale.) |
| | The Zero function (Up ↑ and Down ↓) will reset the scroll to default and allow editing to continue. | |
| 6 | Press the PRGM/Enter → key to accept the desired value. | The value is accepted, and the register is closed. Display shows “P8”. |
| 7 | Press the Backspace ← key to activate the register setting and return to Measure Mode . | Normal Pressure Display. |
| Notes | <ol style="list-style-type: none"> After steps 2 and 3, the Backspace← key will abort the process and return to Measure Mode. After steps 4 and 5, the Backspace← key will abort the edit and close the register. After step 6, the PRGM/Enter→ key will again open the register for edit. During any programming operation, if there is no keypad activity for approximately 1 minute, the operation is aborted and the gauge returns to Measure Mode unchanged. | |

15. Lockout Code Prompt

DESCRIPTION

When a gauge is “locked” for security purposes, it does not allow access to change its operating state without first providing the lockout code. A gauge is “locked” by entering a lockout code in register P0 (See “STEP BY STEP: P0, LOCKOUT CODE” on page 11).

After pressing a key on a locked gauge for a desired function (ZERO, ENG UNITS, PRGM), “L 00” will appear on the display, with the first 0 flashing. This is the prompt to enter the lockout code (similar to a password).

VIEW-ONLY STATUS

If a user attempts to enter **Program Mode** without providing a correct lockout code (password), the gauge briefly provides an error message, and then enters a “view-only” status, denoted by the PRGM indicator flashing. In this mode, all registers (except the lockout code register itself) can be viewed, but not changed.

In this view-only status, the operator navigates through the registers exactly the same as if programming the registers. However, the keys that would change a value are simply ignored by the gauge. Thus, the **PRGM/Enter**→ key will open a register normally; the **Backspace**← key will close the register, and then return to **Measure Mode** as expected.

| STEP BY STEP: ENTERING A LOCKOUT CODE (When Prompted) | | |
|--|---|--|
| Step | Action | Display |
| 1 | After attempting to re-zero, change Engineering Units, or enter Program Mode ... | The display will prompt “L 00” with the first zero flashing for edit (indicating <u>L</u> ockout Code 00). |
| 2 | Press the Up ↑ or Down ↓ keys repeatedly to scroll to the desired numeric value for the flashing digit. | “L x0”, where “x” is the digit being edited. |

| | | |
|---|--|--|
| 3 | Press PRGM/Enter→ key to accept the digit. | The next digit begins flashing for edit. |
| 4 | Repeat steps 2 and 3 for the second digit. | The complete 2-digit value will be accepted. |
| <p>If the correct code was entered, the gauge will perform the requested function. Otherwise, an error message is displayed, and the gauge either returns to Measure Mode, or enters a “view-only” status for the programmable registers (if Program Mode was requested).</p> | | |
| Notes | <ol style="list-style-type: none"> 1. After step 1 or 2, the Backspace← key will abort the process and return to Measure Mode. 2. After step 3, pressing the Backspace← key will abort the current digit and backup to the first digit. Another Backspace← will abort the process and return to Measure Mode. 3. Between steps 1 and 4, the Zero function (Up↑ + Down↓) will clear the entire entry to “00” again. 4. Between steps 1 and 4, if there is no keypad activity for approximately 1 minute, the operation is aborted and the gauge returns to Measure Mode unchanged. | |

16. Serial Port Service

The M2110P Smart Gauge SetPoint models and Current Loop models provide RS-232C communication capability. To use the serial service, connect a standard “dumb terminal” (or personal computer with terminal software) as shown in the wiring diagram. Set the terminal communication for 9600 baud, 8 data bits, no parity, one stop bit, and no handshaking. The terminal should be able to display at least 24 lines and 70 columns.

THE MENU

All programmable items of the gauge are available from the menu. Included with the menu is all current data representing the current programming and operating status.

A sample view of the menu is shown below for reference. The top line identifies the gauge, firmware revision, and copyright. The second line identifies the model (SetPoint, Current Loop), the full scale sensor range, and the sensor identifier. Next is a reminder notice to the operator (explained below).

The Engineering Unit section is next. The first line shows the full scale for the current Engineering Unit, which also identifies the current Engineering Unit. All available Engineering Units are shown with a menu-selection number; the Engineering Unit is changed by simply selecting its corresponding menu-number at the terminal keyboard.

Finally, all programmable registers and functions are formatted on the menu. The menu item includes its menu-selection character, and the current register data as applicable. To change an item, simply select its character from the terminal keypad; the appropriate sub-menu, notes, and instructions are presented for operator entry. Note that the serial menu typically provides more flexibility for entering data values, compared with the gauge’s keypad (for example, more decimal digits of resolution are available).

```
SmartGauge/2110P (v5.00). (c)Copyright 2010 Meriam Instrument.  
SetPoint model. Sensor = 200.0 inH2O;
```

```
-----  
Notice! Changing any value will PAUSE Gauge Operation,  
which will also pause updates to the outputs and display.  
-----
```

```
Current Full Scale: 200.0 inH2O @ 20 Deg C.  
1) inH2O    4) KPa    7) cmH2O    0) User Units  
2) PSI      5) mBar    8) inHg  
3) KGcm2    6) Bar     9) mmHg
```

```
-----  
A) P0, LockOut Code = Disabled  
B) P2, Damp Rate = 0.1 Seconds (Disabled)  
C) P3, Dens. H2O Ref = 20 Deg C.  
D) P4, User FullScale= 1234.0000  
E) P5, SetPoint Ctrl = Both Enabled  
F) P6, SET1 = 30.0000 inH2O  
G) P7, SET2 = 4.0000 inH2O  
H) P8, Dead Band = 0.5 % Full Scale  
J) ReZero Gauge  
K) Restore Factory Zero  
X) EXIT Interactive Menu
```

```
Select Choice:
```

ACCESSING THE MENU

When the gauge is powered up or reset, it will print the menu to the serial port. Also, hitting the ENTER key from the terminal will refresh/reprint the menu. If the terminal is not connected when the gauge first prints the menu, it will be missed; thus, if the terminal is connected after the gauge is already running, it will show nothing. Pressing the ENTER key will establish communications and re-print the menu.

IMPACT ON OPERATION

Use of the serial port service is independent of the mode of the gauge, and vice versa. It is not necessary to change to **Program Mode** to use any of the menu's features, including changing Engineering Units, editing programmable registers, and re-zeroing. The gauge continues its active operation regardless of the serial port service, except for the pausing explained in the next paragraph. Any keypad activity from the front panel of the gauge will also be processed regardless of the serial port status. If entries are made through the keypad and the serial port simultaneously, the last entry received will be active.

While the serial port is actually transferring data, the other functions of the gauge are paused to allow this task to complete. In this paused state, the display is frozen and the outputs are not updating. Typically, the data transfers are very short (for example, printing the menu), and thus the interruption is minimal. However, selecting a programmable register for edit will completely stop normal gauge operation, because the gauge is awaiting the operator's input (data value or selection from a sub-menu). During this state, the display is blanked to prevent mis-readings. As soon as the operator selection or entry is complete, the gauge resumes normal operation.

The Notice of “PAUSE Gauge Operation” near the top of the menu is a reminder about this explanation. It is particularly important when a gauge is in service as an in-process instrument, since the gauge will not respond to process conditions while it is paused.

TIMEOUT

When the menu is displayed, it has no impact on gauge operation or performance. Therefore, the menu will remain displayed indefinitely, or until the operator takes action or the gauge is reset. When the gauge is stopped awaiting operator input, however, the gauge’s display is blanked and the outputs are frozen (for example, awaiting input while editing a register). In this state, if there is no terminal keyboard activity for approximately one minute, the operation will time-out, and the gauge is returned to its operating mode.

DATA MONITORING

Selecting “X” from the menu will EXIT the menu and begin data monitoring. (If the gauge was in **Program Mode**, it will be returned to **Measure Mode** to allow data monitoring. The “X” menu item will include this message as appropriate, when refreshed.)

During data monitoring, every analog-to-digital conversion from the pressure sensor is displayed on the terminal. The additional load of the continuous serial communication will slightly reduce the overall performance of the gauge. The resulting data rate will typically be about ten (10) conversions per second, depending on various operating conditions. Note that the data sent to the terminal *will be damped* according to the damp rate set in register P2.

The data includes the pressure value and Engineering Units, as well as the output status as appropriate (SET1 ON, SET2 ON, or the 4-20 mA value). Note that this status indication is the internal calculated value, as there is no feedback hardware on the gauge. Finally, “Over Pressure!” is indicated if the input pressure exceeds 120% of the full scale sensor range (this indication acts immediately, regardless of the damp rate setting).

If the gauge is taken out of **Measure Mode**, the data monitoring function will pause with a message. (The menu is available at this time, as it is at any time, by hitting ENTER from the terminal.) When the gauge is returned to **Measure Mode**, if the menu was not activated, data monitoring will automatically resume.

Data logging can be accomplished by invoking the appropriate logging function of the terminal software.

To EXIT the data monitoring function, simply hit ENTER on the terminal to restore the menu.

LOCKOUT

If the lockout feature is active (see register P0), the serial menu will prompt for the lockout code when necessary. For security purposes, an asterisk (*) is displayed instead of the character as it is typed. When entering a new lockout code through the serial port, however, the code is displayed as it is typed, since there is no confirmation step.

17. Error Codes

All model M2110P gauges have an error/message feature to inform the operator of problems with the operation or programming of the gauge. These Error Codes and messages are identified and described in the table below.

| ERROR | DESCRIPTION |
|--------------|--|
| “OP” | Overpressure warning. The measured pressure exceeds the full scale pressure by 20% of full scale or more (high or low). Sensor is at risk of permanent damage! |
| E001 | Automatic Shutoff timer has expired (Battery model only); gauge is shutting down normally. |
| E002 | Requested ZERO value is not within 5% of full scale pressure, and therefore ignored. |
| E003 | Requested SET1 or SET2 is out of range. Must be greater than –20 % Full Scale (or 0.0 for absolute gauges), and less than +120 % Full Scale. |
| E004 | Requested SET1 or SET2 is equal to the other on Current Loop models. This configuration is not acceptable. If you are attempting to disable the output, simply set programmable register P5 to 0. |
| E005 | Requested User-Units Full Scale range is less than or equal to 0.0. Value must be greater than 0.0. |
| E006 | User Entered incorrect Lockout Code. Gauge is locked. A view-only status will be entered if Program Mode was requested (see page 22). |
| E010 | Full Scale Range for Engineering Units selected is beyond scale of display (>19,999). This message would be seen, for example, during reset/power up of a 2000 PSI gauge with InH ₂ O (20°C) last selected, since the corresponding full scale display of 55,459.6 InH ₂ O will not fit on the 4½ digit display. |
| | |
| E020 | Low Battery (or power supply) Warning. This error will show repeatedly approximately every 10 seconds, so long as the voltage supply remains low. |
| | |
| E030* | EEProm Error. Display alternates between “E030” and a sub-error code. |

* Error codes of 030 and above indicate hardware or other internal problems; if the problem cannot be corrected by cycling the input power supply on and off, please take note of the error code and operating conditions, and contact Meriam at (216) 281-1100.

18. Installation & Wiring

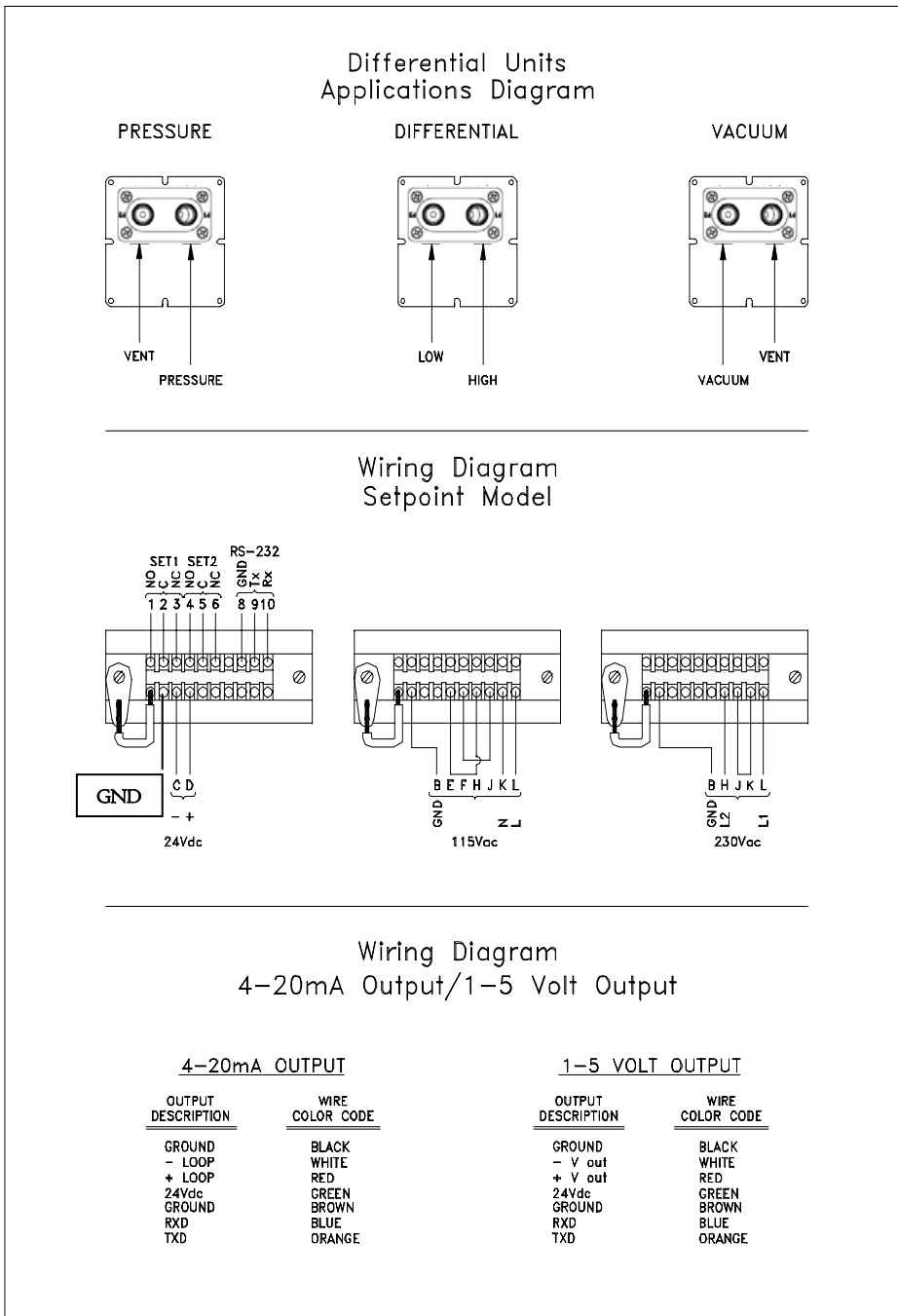

Differential pressure sensors have two pressure connections on the back of the gauge. The diagram at the left shows the correct connections to obtain the desired type of pressure measurement. Gauge-Isolated and Absolute-Isolated pressure gauges have only one pressure connection.

The **SetPoint model** utilizes the multi-function terminal strip shown at the left. This terminal strip has a NEMA 1 rating. SPDT relays are not powered by the gauge internally. Jumpers from the 24Vdc, 110Vac or 220Vac power sources can be used if required.

The **Current Loop model** uses a cannon connector that is designed to meet NEMA 4X requirements. The diagram at the left shows the terminal arrangement.

Wiring schematics for the three and four wire, 4 to 20 mA loops are shown on the following page.

NOTICE

Note: The Smart Gauge comes with 1/8" FNPT pressure port(s). Gauge and Absolute models only use one pressure port. The unused port vents the enclosure/sensor to atmosphere. **DO NOT REMOVE THE SINTERED PLUG (ALLEN HEAD FITTING).** The Smart Gauge should be panel-mounted or held firmly in one *hand* while a small wrench is used to tighten the 1/8" MNPT pipe thread. Do not tighten the fitting without using a wrench on the manifold.

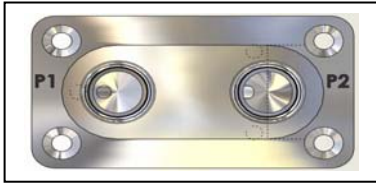

DN & DI Manifold

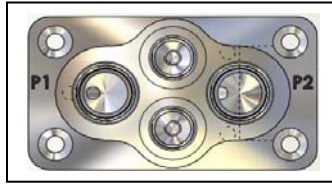

**DI Manifold
(Optional Flushing Ports)**



GI, CI and AI Manifold

Current Loop Model Wiring

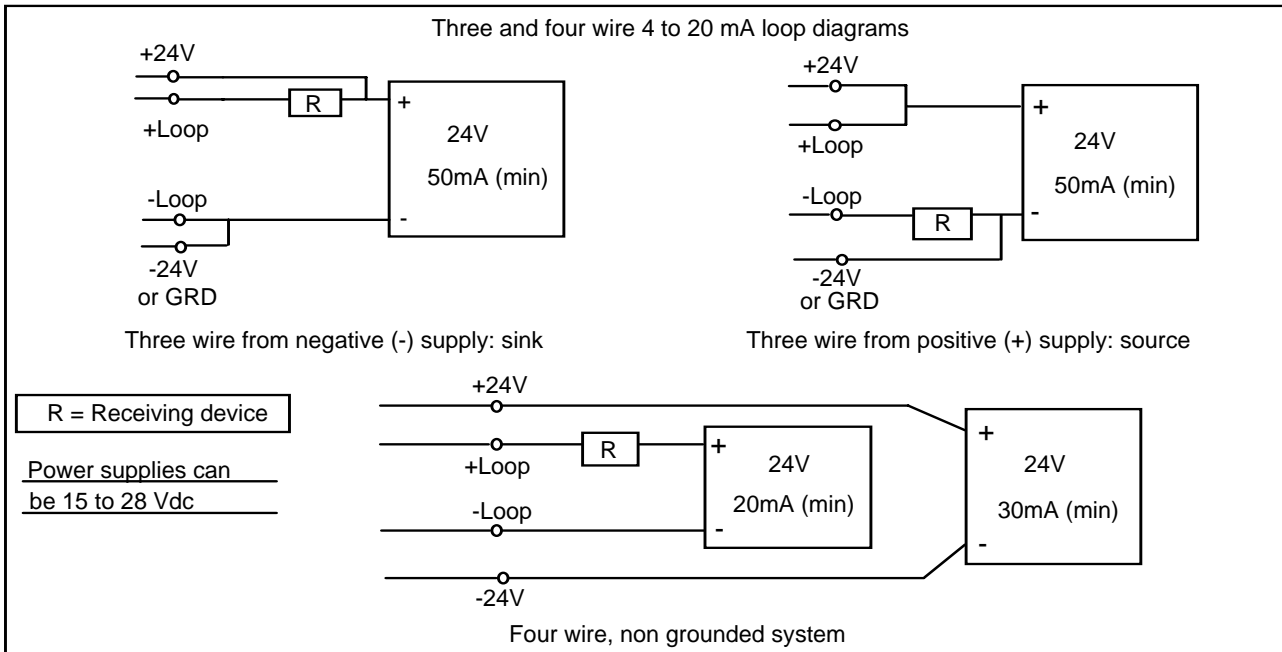

19. Outline Dimensions

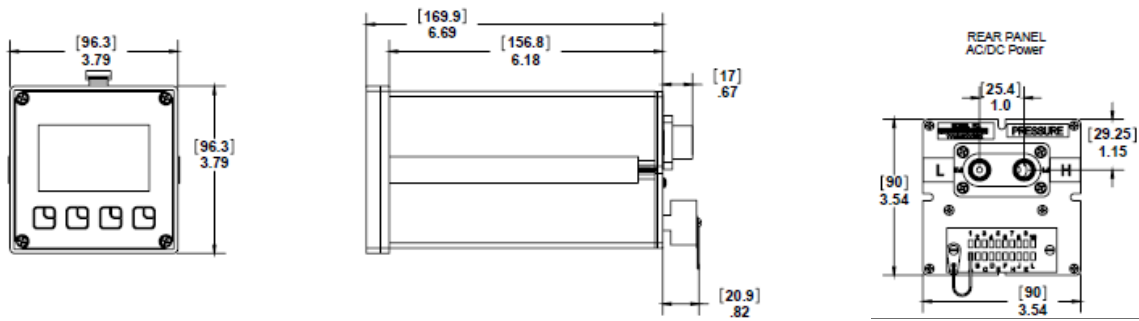

20. Panel Mounting

PANEL MOUNTING CUTOUT DIMENSIONS

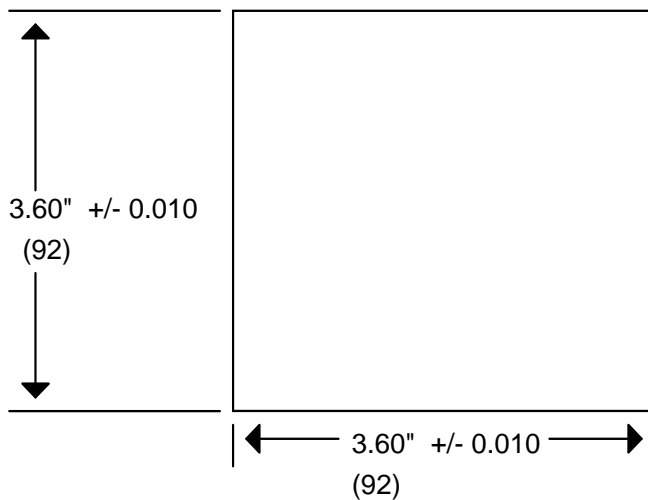

() DIMENSIONS IN MILLIMETERS

1. Make a ¼ DIN panel cutout per drawing.
2. Remove the two 6-32 socket head screws in the grooves at the rear of the gauge.
3. Slide the panel mount jacks out of the groove.
4. Insert the gauge through the front of the panel.
5. From the rear, insert the panel mount jacks in the grooves on the side of the gauge, and slide them firmly against the panel.
6. Replace the two 6-32 socket head screws in the grooves behind the panel mount jacks.
7. Tighten the panel mount jack against the panel with the two socket head screws.
8. Refer to the note on page 28 when making pressure connections.

21. Product Specifications

TYPE & RANGE:

DN: Differential Non-Isolated

CI: Compound Isolated

GI: Gauge Isolated

AI: Absolute Isolated

DI: Wet/Wet Differential Isolated

MEDIA COMPATIBILITY: Non-isolated sensor for clean, dry, non-corrosive gases. Isolated sensor for fluids compatible with 316SS.

ACCURACY*: Indication: $\pm 0.05\%$ of Full Scale (includes combined effects of linearity, repeatability, hysteresis and temperature). Analog output: $\pm 0.05\%$ of Full Scale + 3 counts. AC-powered gauges require 15 minute warm-up. NIST certification supplied.

ZERO DRIFT: $\pm 0.015\%$ of full scale. Zeroing prior to measurement eliminates this effect.

TEMPERATURE:

Storage: $-40\text{ }^{\circ}\text{F}$ to $140\text{ }^{\circ}\text{F}$ ($-40\text{ }^{\circ}\text{C}$ to $60\text{ }^{\circ}\text{C}$)

Operating: $-4\text{ }^{\circ}\text{F}$ to $122\text{ }^{\circ}\text{F}$ ($-20\text{ }^{\circ}\text{C}$ to $50\text{ }^{\circ}\text{C}$)

PRESSURE LIMITS: Twice range for AI and GI sensors. Twice range for DN sensors when pressurized on high side only; 150 PSI (10.5 Kg/cm²) static when applied to both sides of the sensor simultaneously.

DISPLAY: 4 1/2 digit, 0.6 inch (15.24 mm) LCD.

PRESSURE CONNECTIONS: 1/8" female NPT. Brass on non-isolated, 316SS on isolated sensors.

INPUT POWER: SetPoint model is standard with selectable 110V AC 50/60 Hz, 240V AC 50/60 Hz, or 24V DC power.

Battery models are powered by two Lithium "D" Cells. Battery Life is approximately 100 days at a 100% duty cycle.

I/O: Included are an RS 232C interface and two programmable SPDT relays, rated 1.0 amp resistive @ 24V DC, 0.5 amp resistive @ 115V AC.

Option 1: Lithium Battery model with replaceable battery board with automatic shut-off (programmable). No outputs available.

Option 2: Current Loop model with 4-20mA output, 24V DC (50mA) power and RS 232C.

ENCLOSURE: 4 lbs. 1/4 DIN (3.8" X 3.8" X 6.5") aluminum enclosure with epoxy finish. Standard model is NEMA 4X on front panel only. Battery and Current Loop models are NEMA 4X throughout.

MOUNTING: 1/4 DIN panel mounting standard. Options: 2" pipe mount bracket; or portable handle.

| Sensor Type | Available Ranges | Native Engineering Units |
|--------------------------------|---|--------------------------|
| DN = Differential Non Isolated | 0-10, 0-28, 0-200, 0-415, 0-2000 | Inches of H2O @ 20°C |
| GI = Gauge Isolated | 0-15, 0-30, 0-50, 0-100, 0-300, 0-500, 0-1000, 0-3000 | PSI |
| CI = Compound Isolated | -15 to 15, -15 to 30, -15 to 50, -15 to 100, -15 to 500. -15 to 1000, -15 to 3000 | PSI |
| AI = Absolute Isolated | 0-17, 0-38, 0-100, 0-1000 | PSIA |
| DI = Differential Isolated | 0-5, 0-15, 0-30, 0-100, 0-300, 0-500, 0-1000 | PSID |

22. Range Limits and Indication

| Sensor Type | Hard Under Range | Soft Under Range | Certified Range (F.S.) | Soft Over Range | Hard Over Range |
|-------------|-------------------------|------------------------|------------------------|-----------------|-----------------|
| DN | Under -20% ¹ | -20 to 0% | 0 to 100% | 100 to 120% | Over 120% |
| DI | Under -20% ² | -20 to 0% | 0 to 100% | 100 to 120% | Over 120% |
| GI | Under -20% ³ | -20 ³ to 0% | 0 to 100% | 100 to 120% | Over 120% |
| CI | NA ⁴ | NA ⁴ | 0 to 100% | 100 to 120% | Over 120% |
| AI | NA ⁵ | NA ⁵ | 0 to 100% | 100 to 120% | Over 120% |

Notes:

¹ DN units will measure to -20% (or -10 PSID, whichever is greater pressure relative to absolute zero) and +120% of full scale pressure. Calibration certification is for 0 – F.S. (Full Scale Only).

² DI units will measure to -20% (or -150 PSI, whichever is greater pressure relative to absolute zero) and +120% of full scale pressure. Calibration certification is for 0 – F.S. (Full Scale Only).

³ GI units will measure to -20% (or -10 PSIG, whichever is greater pressure relative to absolute zero) and +120% of full scale pressure. Calibration certification is for 0 – F.S. (Full Scale Only).

⁴ CI units will measure to negative barometric pressure (typically -14.7 PSIG) and to +120% of full scale pressure. Calibration certification is for -14.5 PSIG to F.S. (Full Scale Only).

⁵ AI units will measure to +120% of full scale pressure. Calibration certification is for 0 PSIA to F.S. (Full Scale Only).

Hard Over & Under:
Display will read "OP" (Under -20% or Over 120%).

Soft Over & Under:
Display will still read out at (± 20%).

23. Service and Calibration

In the event an M2110 requires service or needs to be returned for factory recertification, battery replacement, or re-calibration, please contact Meriam at the numbers listed below. The battery board should only be replaced by properly trained technicians in a controlled environment. Contact Meriam for further details.

DO NOT send any unit in for service without first contacting Meriam for a Return Material Authorization (RMA) number. If this number has not been obtained and clearly marked on the return packaging, the unit will be returned at the shipper's expense. An RMA number will be provided by the Meriam Repair Department when you call, fax or e-mail your information. Certification for Non-Hazardous Materials will also be required. The RMA number must accompany all incoming packages to insure proper tracking, processing and repair work.

To assist us in processing your service request, please have the Model & Serial Number of the unit available when you call. This information is located on the product label.

Meriam Process Technologies
10920 Madison Avenue
Cleveland, Ohio 44102

TELEPHONE: (216) 281-1100
FAX: (216) 281-0228

E-mail: service1@meriam.com
Web Site: www.meriam.com