

MPG2000BBL-D4-M9 Operating Instructions

Precautions

Approved Locations

The MPG2000BBL series is approved for use in the following Hazardous Locations.

IS Class I Div 1 Gp ABCD

T3C Ta = -40°C to 82°C; T4 Ta = -40°C to 66°C.

CL I Zone 0 AEx/Ex ia IIC

T3 Ta = -40°C to 82°C; T4 Ta = -40°C to 66°C

Installation

- ✓ Read these instructions before installing the gauge. Configuration may be easier before the gauge is installed. Contact the factory for assistance.
- ✓ Installation instructions must be strictly followed in compliance with Intrinsic Safety National Standard NEC 504 or ANSI/ISA RP 12.6 and the National Electrical Code.
- ✓ Outdoor or wash down applications requires installation in a NEMA 4X housing.
- ✓ Use fittings appropriate for the pressure range of the gauge.
- ✓ Due to the hardness of stainless steel, it is recommended that a thread sealant be used to ensure leak-free operation.
- ✓ For contaminated media use an appropriate screen or filter to keep debris out of gauge port.
- ✓ Avoid permanent sensor damage! NEVER insert objects into gauge port or blow out with compressed air.
- ✓ Remove system pressures before removing or installing gauge.
- ✓ Install or remove gauge using a wrench on the hex fitting only. Do not attempt to turn by forcing the housing.

Dimensions

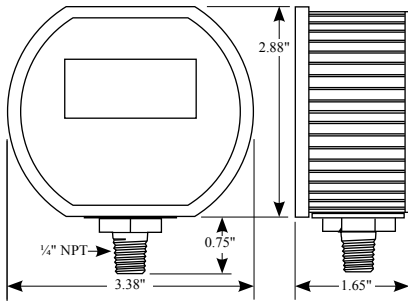

Types of Gauges

Gauge reference reads zero with the gauge port open.

Bipolar ranges read positive pressure and vacuum in the same units, and zero with the gauge port open.

Compound ranges read positive pressure in psig and vacuum in inHg, and zero with the gauge port open.

Sealed reference reads zero with the gauge port open and is referenced to 14.7 psi. Used for 1000 psi and up.

Absolute reference reads atmospheric pressure with gauge port open and zero at full vacuum.

Display and Keypad

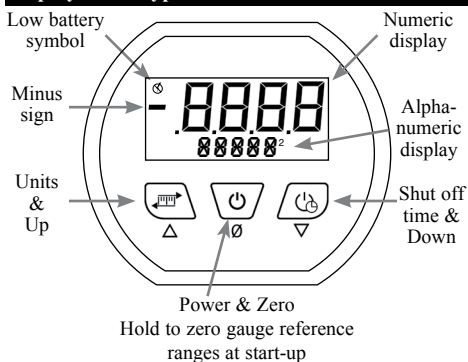

Operation

- ✓ Use within the pressure range indicated on gauge label.
- ✓ Avoid permanent sensor damage! Do not apply vacuum to gauges not designated for vacuum operation.
- ✓ Use only with media compatible with 316L stainless steel.
- ⚠ Gauges are not for oxygen service. Accidental rupture of sensor diaphragm may cause silicone oil inside sensor to react with oxygen.
- ✓ The MPG2000BBL series gauges must only be operated in specified ambient temperature ranges.

Maintenance

- ✓ The non-metallic cover of the pressure gauge is considered to constitute an electrostatic discharge hazard. Clean only with a damp cloth.
- ✓ Batteries must be replaced when the low battery indication comes on to prevent unreliable readings.
- ✓ WARNING: Replace batteries with approved type in non-hazardous locations only.
- ✓ Approved batteries are two Panasonic LR03 1.5 V AAA alkaline cells. Replace both batteries at the same time.
- ⚠ WARNING: Substitution of batteries may impair intrinsic safety. Improper voltages will damage the gauge.
- ✓ WARNING: Substitution of components may impair intrinsic safety. Do not modify the gauge.
- ✓ These products do not contain user-serviceable parts except for batteries. Contact factory for repairs, service, or refurbishment.

Operation

Power-Up

Press and hold the  button for approximately 1 second. The display is tested, the full-scale range is indicated, the display segments are briefly shown again, then the actual pressure and units are displayed.

Power Up with Zero

This applies to gauge reference models only. Absolute reference gauges do not use the zero feature since they read atmospheric pressure under normal conditions.

Be sure the gauge port is exposed to normal atmospheric pressure. The zeroing function is only activated at each power-up and the stored zero correction is erased when the gauge is shut off.

Press and hold the  button. The display is tested.

Continue to press the  button until *0000* is displayed.

Release the button. The gauge is now zeroed and goes through the startup sequence.

Attempting to zero the gauge with greater than approximately 3% of full-scale pressure or vacuum applied will cause the display to alternately indicate *Err 0* and the actual pressure. The gauge must be powered down to reset the error condition.

Normal Operation

The display indicates the pressure reading updated approximately 3 times per second. The auto shutoff timer starts when the gauge is powered up or whenever a button is pushed, unless the shutoff time was set for on/off operation.

If excessive vacuum is applied to a pressure-only gauge, the display will indicate *-Err* until the vacuum is released. Applying vacuum to a gauge designed for pressure may damage the pressure sensor.

If excessive pressure is applied (112.5% over range), an out-of-range indication of *1---* or *1.-.-* will be displayed depending on model.

When an auto shutoff timer is used, the display indicates *OFF* five seconds prior to auto shutoff. Any button can be pressed to keep the gauge on and reset the auto shutoff timer.

Display Backlighting

Display backlighting will operate for one minute when a button is pressed provided the front light sensor detects low ambient light levels. Backlighting may not be apparent under some lighting conditions.

Battery Replacement

A low battery indication (either LOBAT or the symbol  depending on the model) will be shown in the upper left-hand corner of the display when the battery voltage falls sufficiently. The batteries should be replaced when the indicator comes on or unreliable readings may result.

WARNING: Replace batteries with approved type in non-hazardous locations only. Replace batteries with two Panasonic LR03 1.5 V AAA alkaline cells.

Replace both batteries with new ones at the same time. Do not mix different types of batteries. Substitution of components may impair intrinsic safety.

1. Remove the 6 Phillips screws on the back of the unit.
2. Remove batteries by lifting up the positive end of the battery (opposite the spring) taking care not to bend the spring.
3. Discard old batteries properly, do not discard into fire, sources of extreme heat, or in any hazardous manner.
4. Install batteries with correct orientation. The negative (flat) end of each battery should be inserted first facing the battery holder spring.
5. Replace the back cover, including the rubber gasket.

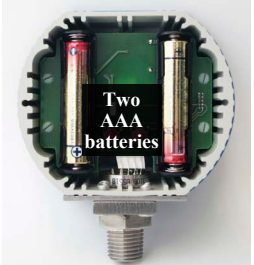

DS-MPG2000BBL rev. 01-15

Operation—continued

Shut-Down



To shut off the gauge manually at any time, press and hold the  button until the display indicates *OFF* (about 2 seconds) and then release.

If the gauge was set up without auto shutoff, it will stay on until manually shut off or until the batteries are depleted. Turn gauge off when not in use to conserve batteries.

Engineering Unit Selection

The selected engineering unit is stored in non-volatile memory and will be retained even with the gauge off or batteries removed. The available engineering units depend on the sensor range.

With the gauge in the normal operating mode, press and hold the  button until the lower units display starts blinking.

Use the  and  buttons to navigate through engineering unit list. When the desired unit is displayed, press and release the  button to save your selection and return to normal operation.

Standard psig units are mathematically converted to the newly selected engineering unit. When the gauge is powered up, the originally configured psig range is displayed followed by the conversion to the selected engineering unit.



Compound (inHg/psig) gauges can be changed to display single-unit vacuum/pressure readings (\pm psig) when in the user configuration mode.

If no buttons are pressed the gauge will return to normal operating mode in approximately 15 seconds.

Auto Shutoff Time Selection

The selected shut off time is stored in non-volatile memory and will be retained even with the gauge off or batteries removed.

With the gauge in the normal operating mode, press and hold the  button. Release the button when the auto shutoff time is displayed.

Use the  and  buttons to select *AST M* of 1, 2, 5, 10, 15, 20 or 30 minutes, or *AST H* of 1, 2, 4, or 8 hours, or *AST 0* if auto shutoff is to be disabled.

When the desired auto shutoff time is displayed, press and release the  button to save the selection and return to normal operation.

MPG2000BBL-D4-M9 Configuration Instructions

User Configuration Access

User configuration allows access to several functions.

- Revert back to the factory configuration
- Change min/max operation
- Convert a compound gauge to a bipolar gauge
- Calibrate the gauge

Configuration must only be done in a non-hazardous area.

Remove the 6 Phillips screws on the back of the unit and remove the rear cover.

Move the switch on the circuit board down to the ENABLE position.

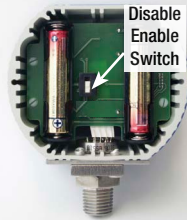

User Configuration Access

With the gauge off, press and hold the Δ button.

Then press the \square button.

Release all buttons when the display indicates *CFG* and the program version.

The full-scale range is indicated and the display is tested.

The display then indicates with the first underscore blinking, with *CFGPC* (configuration pass code) on the lower display.

Note: The gauge will automatically revert to normal operation if no buttons are pressed for approximately 15 seconds. To cancel and return to normal operation, press and release the \square button without entering any pass code characters.

Proceed to the User Configuration Pass Code Entry section.

User Configuration: Pass Code Entry

The factory default is 3510, but this may be changed by the user under the Pass Code Configuration section. If an incorrect pass code is entered, the gauge will return to the start of the pass code entry sequence.

1. Use the Δ or ∇ buttons to set the first digit to 3.
2. Press and release the \square button to move to the next position. The 3 will remain, and the second position will be blinking.
3. Use the Δ or ∇ buttons to select 5.
4. Press and release the \square button to index to the next position. 35 will remain, and the third position will be blinking.
5. Use the Δ or ∇ buttons to select 1.
6. Press and release the \square button to index to the next position. 351 will remain, and the fourth position will be blinking.
7. Use the Δ or ∇ buttons to select 0.
8. Press and release the \square button to proceed.

User Configuration: Factory or User

This gives the choice of resetting the gauge features to the factory settings or continuing with user configuration. The upper display will be blank, and the lower display will indicate either *USER_* or *FCTRY*.

If *FCTRY* is selected, the existing user configuration will be replaced by the original factory configuration.

To select *FCTRY*, press and release the Δ button.

With *FCTRY* displayed press and release the \square button to restore the factory configuration and restart the gauge.

If *USER_* is selected, the user configuration can be modified as described in the following steps.

To select *USER_*, press and release the ∇ button.

With *USER_* displayed press and release the \square button to continue.

The configuration parameters may vary depending on the model.

User Configuration: Min/Max

M9 versions are configured with minimum and maximum functions turned off. Min/Max can be enabled in the User Configuration mode.

Max/Min Configuration

While in User Configuration mode, use the Δ and ∇ buttons to select from the following.

--/-- Min/Max Capture feature is disabled

MX/MN Both highest and lowest values will be captured

MX/-- Only highest value will be captured

--/*MN* Only lowest value will be captured

Press and release the \square button to move to the next parameter.

Max/Min Memory

The upper display will indicate *c / r*.

Use the Δ and ∇ buttons to select from the following.

AUTO Automatically clear maximum and minimum values when the gauge is powered off.

MAN Manually clear maximum and minimum values.

For compound range models, press and release the \square button to move to the next parameter.

For all other models press and release the \square button to save the user configuration and restart the gauge. Move the switch on the circuit board up to the *DISABLE* position and replace the rear cover including the rubber gasket.

Using Minimum and Maximum Readings

Minimum and maximum readings are continuously stored and updated whenever the gauge is on. The stored readings can be manually cleared if desired. The *MAX* and *MIN* memory can be configured to save or clear the reading whenever the gauge is off.

Press and hold the \square button for about 1 second until *MAX* is displayed alternating with the units. The maximum reading will be continuously updated. The gauge may be left in this mode.

After *MAX* is displayed, press and hold the \square button for about 1 second until *MIN* is displayed alternating with the units. The minimum reading will be continuously updated. The gauge may be left in this mode.

If excessive vacuum is applied to a pressure-only gauge while in this mode, the display will indicate *-Err* until the *MAX/MIN* readings are cleared.

After *MIN* is displayed, press and hold the \square button again for about 1 second until ***** is displayed. The *MAX* and *MIN* memory is not erased and the gauge returns to normal operation.

Press and continue to hold the \square button until the display indicates *clr MX/MN* (about 3 seconds total) and then release the button. Both maximum and minimum values are cleared and the gauge returns to the normal mode and displays the current pressure.

User Configuration: Compound/Bipolar Models

This will only appear with 15, 100, or 200 psig ranges that were originally ordered as compound gauges.

Use the Δ and ∇ buttons to select from the following.

-/*EU* Vacuum is indicated as negative pressure in the selected engineering units

CMPND Vacuum is negative INHG, pressure is PSIG.

This setting disables engineering unit selection.

Press and release the \square button to save the user configuration and restart the gauge.

This completes the configuration for this model.

Move the switch on the circuit board up to the *DISABLE* position and replace the rear cover including the rubber gasket.

Changing the Pass Code

User-defined pass code configuration allows changing of the factory 3510 pass code to new value for configuration and calibration.

Configuration must only be done in a non-hazardous area. Remove the rear 6 Phillips screws and remove the rear cover.

Move the switch on the circuit board down to the *ENABLE* position.

View Or Change User Configuration Pass Code

With the unit off, press and hold the Δ button, then press the \square button.

Release all buttons when the display indicates *CFG*.

View Or Change User Calibration Pass Code

With the unit off, press and hold the ∇ button, then press the \square button.

Release all buttons when *CAL* is shown.

Enter Access Code 1220

Before the unit enters the view or change pass code mode, the display initially indicates with the first underscore blinking, and with *CFGPC* or *CALPC* on the character display.

Note: The gauge will automatically revert to normal operation if no buttons are operated for approximately 15 seconds.

To cancel and return to normal operation, press and release the \square button without entering any pass code characters.

Use the Δ and ∇ and \square buttons to enter the 1220 pass code.

Press and release the \square button to proceed.

Note: If an incorrect access code was entered, the gauge will return to the start of the access code entry sequence.

Once the access code has been entered correctly, the display will indicate the existing user-defined pass code with either *CFGPC* or *CALPC* on the character display.

1. Press the Δ or ∇ button to select the first character of the new pass code.
2. When the desired first character is displayed, press and release the \square button to move to the next character.
3. Repeat above until the entire pass code is complete.
4. To exit, press and hold the \square button. Release the \square button when the display indicates - - - to restart the gauge.
5. Move the switch on the circuit board up to the *DISABLE* position.
6. Replace the back cover, including the rubber gasket.

MPG2000BBL-D4-M9 Calibration Instructions

Calibration Preparation

Calibration must only be done in a non-hazardous area. See the Precautions section.

Gauges are calibrated at the factory using equipment traceable to NIST. There is no need to calibrate the gauge prior to use.

Calibration should only be performed by qualified individuals using appropriate calibration standards and procedures.

Contact factory if assistance is required. Gauges can be returned to factory for certified calibration and repairs. NIST traceability is available.

Calibration intervals depend on your quality control program requirements. Many customers use an annual calibration cycle.

The calibration equipment should be at least four times more accurate than the gauge being calibrated.

The calibration system must be able to generate and measure pressure and/or vacuum over the full range of the gauge.

A vacuum pump able to produce a vacuum of 100 microns (0.1 torr or 100 millitorr) or lower is required for vacuum and absolute gauges.

Warning: Never apply vacuum to gauge not designated for vacuum service. Permanent sensor damage may result. It is good practice to install fresh batteries before calibration.

Allow the gauge to equalize to normal room temperature (about 20 minutes minimum) before calibration.

Calibration

See the Calibration Preparation section. See rear label of gauge for model identification and range.

Remove the 6 Phillips screws on the back of the unit and remove the rear cover.

Move the switch on the circuit board down to the ENABLE position.

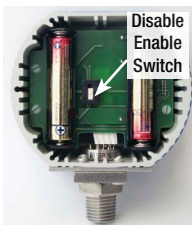

Entering Calibration Mode

With the gauge off, press and hold the ▽ button, then press the ◻ button.

The program version is displayed, then *CAL*.

Release all buttons when the display indicates *CAL*.

The display begins by indicating the full-scale positive pressure rating of the gauge in the engineering units as configured by the factory, and then shows all display segments.

Before the gauge enters the calibration mode, the display initially indicates with the first underscore blinking, with *CALPC* (calibration pass code) on the lower display.

Note: The gauge will automatically revert to normal operation if no buttons are operated for approximately 15 seconds. To cancel and return to normal operation, press and release the ◻ button without entering any pass code characters.

Enter the pass code as described in the User Configuration Pass Code Entry section. The default is 3510, but this is user changeable.

Continue to the Calibration Mode section.

Calibration—continued

Calibration Mode

The gauge remains in the calibration mode until restarted manually or power is removed. Features not related to calibration are disabled.

The calibration may be performed in any of the available engineering units as well as percent (PCT). Compound range models are set for the same engineering units for pressure and for vacuum.

For greatest calibration accuracy, use the △ and ▽ buttons to select engineering units with highest number of display counts.

Press and release the ◻ button when the desired engineering units are displayed.

Sensor Suggested units for calibration

3 PSI	3.000 PSI
5 PSI	5.000 PSI
15 PSI	775.7 MMHG (TORR)
30 PSI	69.20 FTH2O
60 PSI	60.00 PSI
100 PSI	7.031 KG/CM2
200 PSI	407.2 INHG
300 PSI	610.8 INHG
500 PSI	500.0 PSI
1000 PSI	70.31 KG/CM2
3000 PSI	6108 INHG
5000 PSI	5000 PSI
Any	100.00 PCT (percent)

The display will then indicate the currently applied pressure in the engineering units selected for calibration.

△ and ▽ Button Operation

Each time one of the △ or ▽ buttons is pressed and released quickly, a small change is made to the digitized pressure signal. It may take more than one of these small changes to result in a single digit change on the display.

To make larger changes, press and hold the appropriate △ or ▽ button. After about one second, the display will begin to change continuously.

Release the button to stop.

Then make fine adjustments by pressing and quickly releasing the appropriate button.

Gauge Reference Pressure Gauges

Apply zero pressure by venting the gauge port to atmosphere. The character display will alternate between *ZERO* and *CAL*.

Press the △ and ▽ buttons to obtain a zero indication on the gauge display.

Apply full-scale pressure. The character display will alternate between *+SPAN* and *CAL*.

Press the △ and ▽ buttons to match the gauge display to the full-scale pressure reading on the calibrator.

Apply 50% full-scale pressure. The character display will alternate between *+MID* and *CAL*.

Press the △ and ▽ buttons to match the gauge display to the 50% of full-scale pressure on the calibrator.

Calibration—continued

Gauge Reference Vacuum Gauges

Apply zero pressure by venting the gauge port to atmosphere. The character display will alternate between *ZERO* and *CAL*.

Press the △ and ▽ buttons to obtain a zero indication on the gauge display.

Apply full-scale vacuum. The character display will alternate between *+SPAN* and *CAL*.

Press the △ and ▽ buttons to match the gauge display to the full-scale vacuum indication on the calibrator.

Apply 50% full-scale vacuum. The character display will alternate between *+MID* and *CAL*.

Press the △ and ▽ buttons to match the gauge display to the 50% of full-scale vacuum indication on the calibrator.

Absolute Reference Gauges

Apply full vacuum. The character display will alternate between *ZERO* and *CAL*.

Press the △ and ▽ buttons until the display indicates zero.

Apply full-scale pressure. The character display will alternate between *+SPAN* and *CAL*.

Press the △ and ▽ buttons to match the gauge display to the full-scale pressure reading on the calibrator.

Apply 50% of full-scale pressure. The lower display will alternate between *+MID* and *CAL*.

Press the △ and ▽ buttons to match the gauge display to the 50% of full-scale reading on the calibrator.

Compound and Bipolar Gauges

In addition to the steps described above for pressure gauges, apply full-scale vacuum. The character display will alternate between *-SPAN* and *CAL*.

Press the △ and ▽ buttons to match the gauge display to the full-scale vacuum reading on the calibrator.

For bipolar (±) and -30.00inHg/+15.00psig compound range models only, apply 50% full-scale vacuum. The character display will alternate between *-MID* and *CAL*.

Press the △ and ▽ buttons to match the gauge display to the 50% of full-scale vacuum on the calibrator.

Save Calibration

Once the adjustments are complete, press and hold the ◻ button until the display indicates - - - then release the button to store the calibration parameters in non-volatile memory and restart the gauge.

Verify the pressure indications at 0%, 25%, 50%, 75% and 100% of full scale.

Move the switch on the circuit board up to the DISABLE position.

Replace the back cover, including the rubber gasket.



10920 Madison Ave
Cleveland, OH 44102
Phone: 216-281-1100
Fax: 216-281-0228
meriam.com
sales@meriam.com

Meriam maintains a constant effort to upgrade and improve its products. Specifications are subject to change without notice. Consult factory for your specific requirements.